

User's Guide

LA5034

Operation Manual



Content

General safety summary	I
Introduction.....	II
Chapter 1 Getting started	1
System Requirements.....	2
Installing Hardware	3
Installing Software.....	6
User Interface	10
Chapter 2 Menu.....	11
File	12
View	13
Setup.....	14
Analyzer.....	15
Help.....	16
Chapter 3 Advanced.....	17
Clock Panel.....	18
Bus Panel.....	19
Waveform Panel.....	22
Measurement Panel.....	24
Export Data	25
Chapter 4 Trigger and Plug	26
Base Trigger Setup	27
Advance Trigger Setup.....	29
Plug Manager.....	30
Appendix	31
Hardware Specification	32
Channels.....	33
Block Diagram.....	35
Cleaning and maintenance	36

General safety summary

Understand the following safety precautions to avoid injuries and to prevent damage to the product or the product of any product link. To avoid possible dangers, be sure to use the product in accordance with the regulations.

- n **Only qualified personnel to perform maintenance procedures.**
- n **Prevent fire and personal injury.**
- n **Use the right power cord.** Only the country in which the authorized use of this product for the power line.
- n **Correctly inserted.** Probe or test voltage wire connected to the source, please do not plug.
- n **Products will be grounded.** This product through the power of the grounding wire grounding. To avoid electric shocks, grounding conductor must be connected to. In this connection the import or export of products before the end, be sure to correct grounding for this product.
- n **Properly connected probe.** Probe the ground with the same potential. Do not connect high-voltage ground.
- n **See all the terminals rating.** To avoid excessive current fire and the impact, see the product of all the ratings and tags; please connect products in the product manual inspection prior to understand the detailed ratings information.
- n **Do not run the product if you open the cover or panel.**
- n **Avoid the exposed circuit.** Do not connect power after contact with the exposed joints and components.
- n **Suspected products to failure do not operate.** If you suspect that this product has been a failure, can be qualified maintenance personnel to be checked.
- n **Maintain proper ventilation.**
- n **Do not operate in the humid environment.**
- n **Do not flammable and explosive environment operation.**
- n **Please keep the product clean and dry surface.**

Introduction

LA5034 is devoted to the observation of digital signal test and measurement equipment. It has multi-line oscilloscope and other advantages of automatic test equipment. The use of advanced large-scale integrated circuits, integrated USB 2.0, CPLD, FPGA, high-frequency digital circuitry, embedded systems, and other advanced technology, using plug-and-play USB power supply, compared to the traditional desktop LA5034 with a higher cost performance, portable, easy-to-use, the expansion of the advantages of good, instead of the traditional equipment is the best choice. LA5034 is a 500MHz, 34 cost-effective channels LA5034, can be used for digital circuit development, measurement, analysis and debugging, electronic research and development, electronic measurement engineers, college students in scientific research and development and teaching assistant. LA5034 also have a variety of new means of measuring equipment.

The LA5034 have a sufficient number of input channels capable of simultaneously observing a lot of information or data flow direction control information, and in some way to capture narrow pulse interference

The LA5034 has delayed the ability to capture the required observation points around the waveform, in a variety of digital information capture function.

LA5034 have memory capacity, to be able to see the occasional error messages, and the memory can find fault in the source state.

The LA5034 with intuitive and flexible displays to facilitate dynamic analysis can transform the information, you can use the binary, decimal, hexadecimal or ASCII that information to facilitate the repair process and debug.

The LA5034 triggered in a variety of ways, can be a very long data stream, the analysis of that part of the information to make accurate positioning, which caught right of useful information for software analysis, it can use its tracking function trigger operation procedures. For hardware, trigger function can be detected in the system and that the interference and Burr.

The LA5034 has reliable Burr detection ability. As competition in digital circuit, the signal crosstalk, interference and power coupling factors, often mixed with irregular signal in the burr, which will run from wrong circuit. LA5034s can be detected through special burr technology to capture and display.

Chapter 1 Getting started

This chapter focuses on the following topics:

- u System Requirements
- u Installing hardware
- u Installing software
- u Understanding of the user interface

System Requirements

I Minimum System Requirements

Operating System

Windows me/NT/2000/XP/Vista

Memory

128MB

Graphic Card

Microsoft DirectX supported

Screen resolution: 1024x768

Color depth: 16bit

I Recommended System Requirements

Operating System

Windows me/NT/2000/XP/Vista

Memory

256MB

Graphic Card

Microsoft DirectX supported

Screen resolution: 1024x768

Color depth: 16bit

Installing Hardware

1. Connect the A-Type Plug of USB cable to your PC's USB port.
2. Connect the B-Type Plug of USB cable to LA5034's USB port.
3. New hardware is found.



4. New hardware search wizard starts.



5. New hardware search wizard starts to search



6. New hardware wizard installs software



7. Finish new hardware search wizard.

**Caution:**

Do not disconnect any device from the USB bus while the computer is communicating with the LA5034, or you may lose data and/or your ability to communicate with the LA5034.

If the LED is illuminated but the turns off, the computer has lost communication with the LA5034. To restore communication, disconnect the USB cable from the computer, and then reconnect it. This should restore communication, and the LED should turn back on.

Installing Software

1. While in Windows, insert the installation CD into the CD-ROM drive.
2. The installation should start up automatically. Otherwise in Windows Explorer, switch to the CD-ROM drive and run "Setup.exe".



3. The LA5034 Installation is started. Click 'Next' to continue.

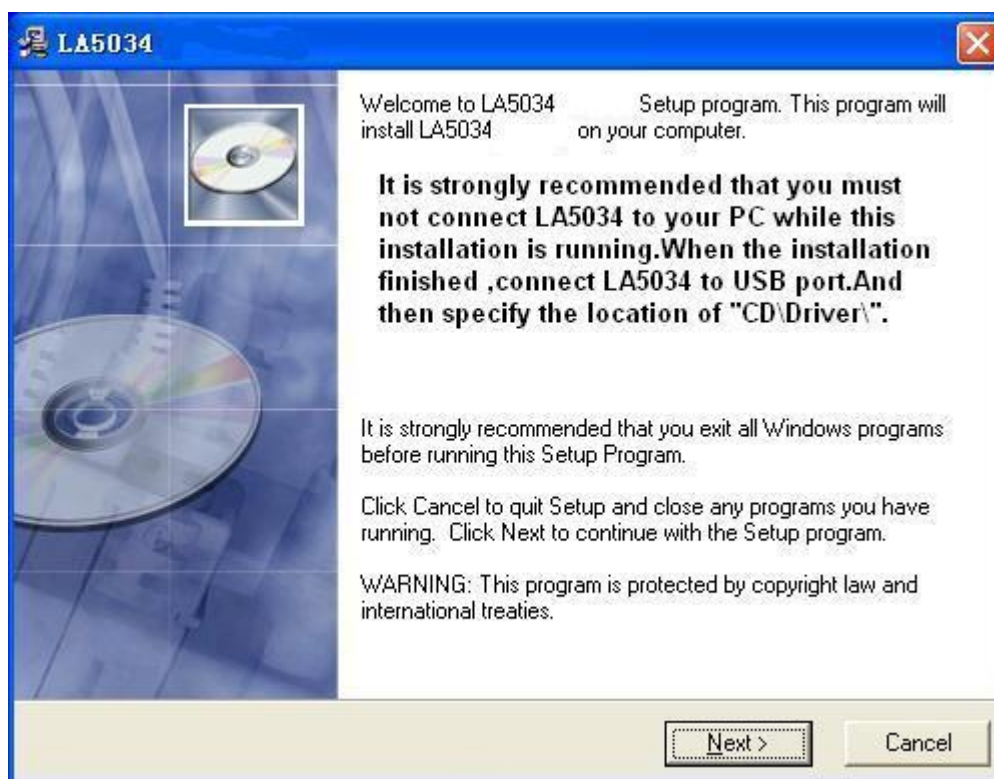

4. Choose a destination directory. Click 'Next' to continue.

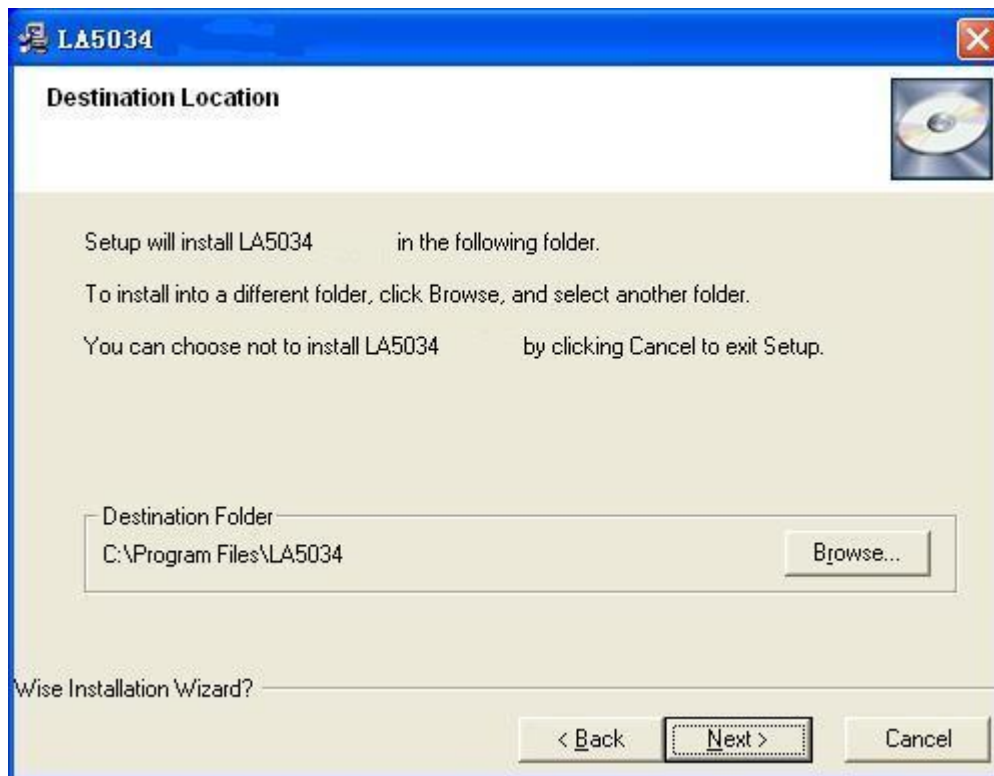

5. Check the setup information. Click Next to start copying of files.

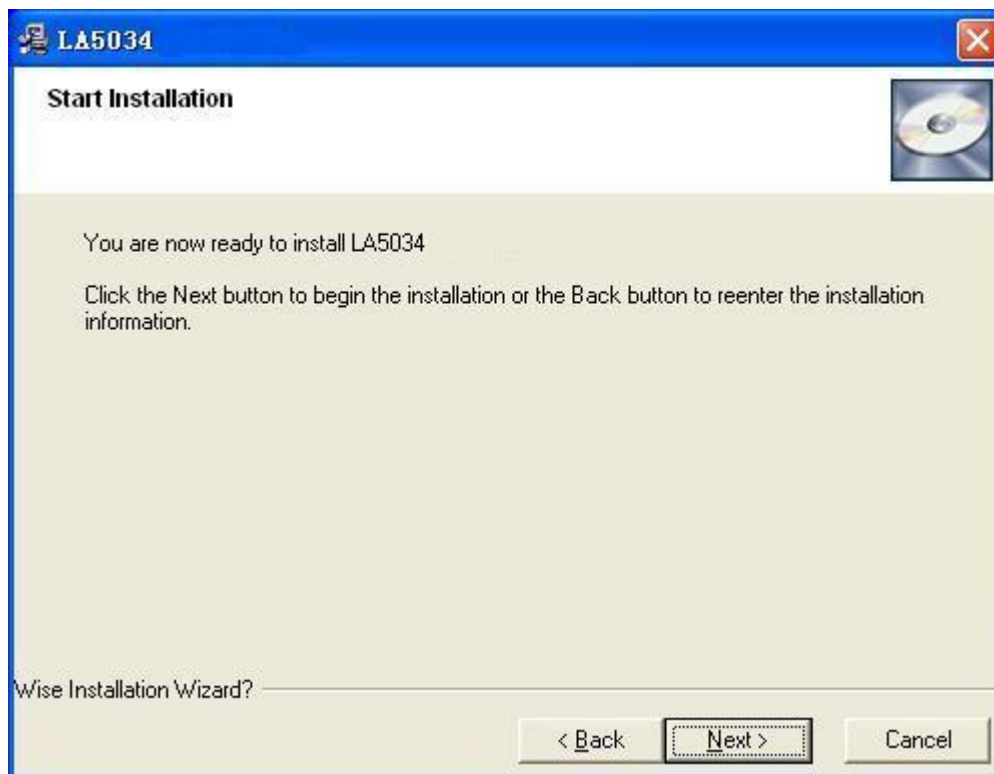

6. This Status dialog is displayed during copying of files.



7. Updating Your System Configuration.

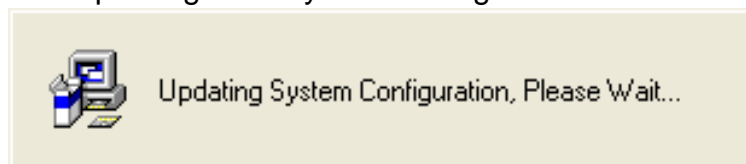

8. The installation is complete.

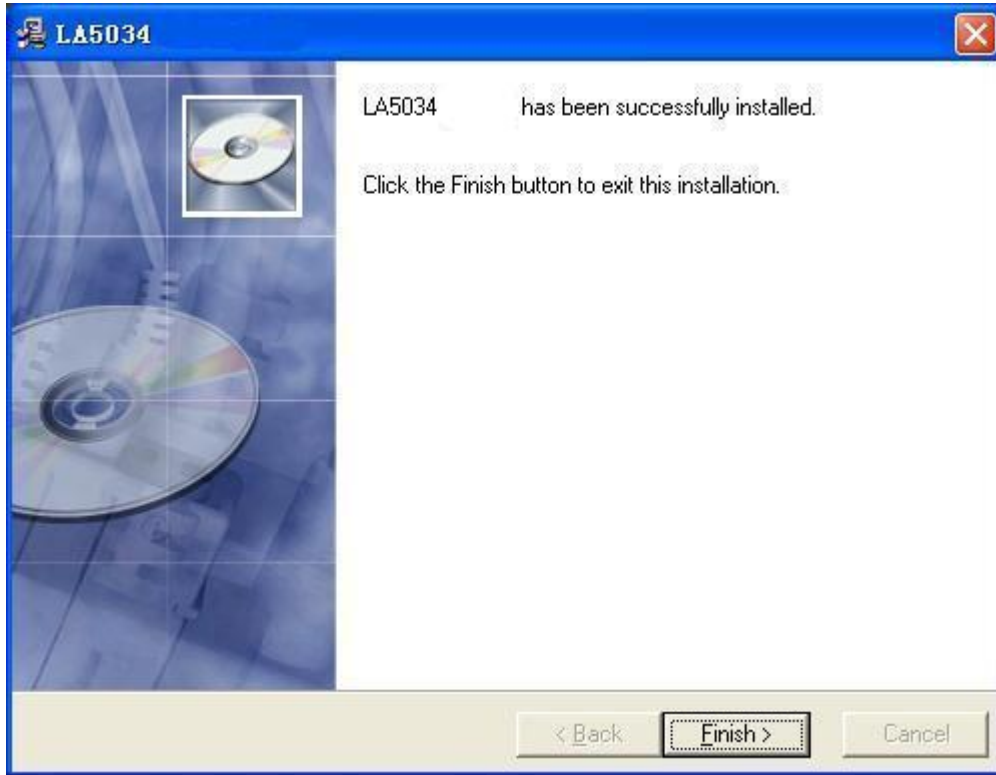

User Interface

LA5034 provide users a simple and full-featured interface so that users do not have to spend a lot of time to learn.

LA5034 provide clock panel, waveform panel, bus panel, measurement panel, trigger panel and plug manager.

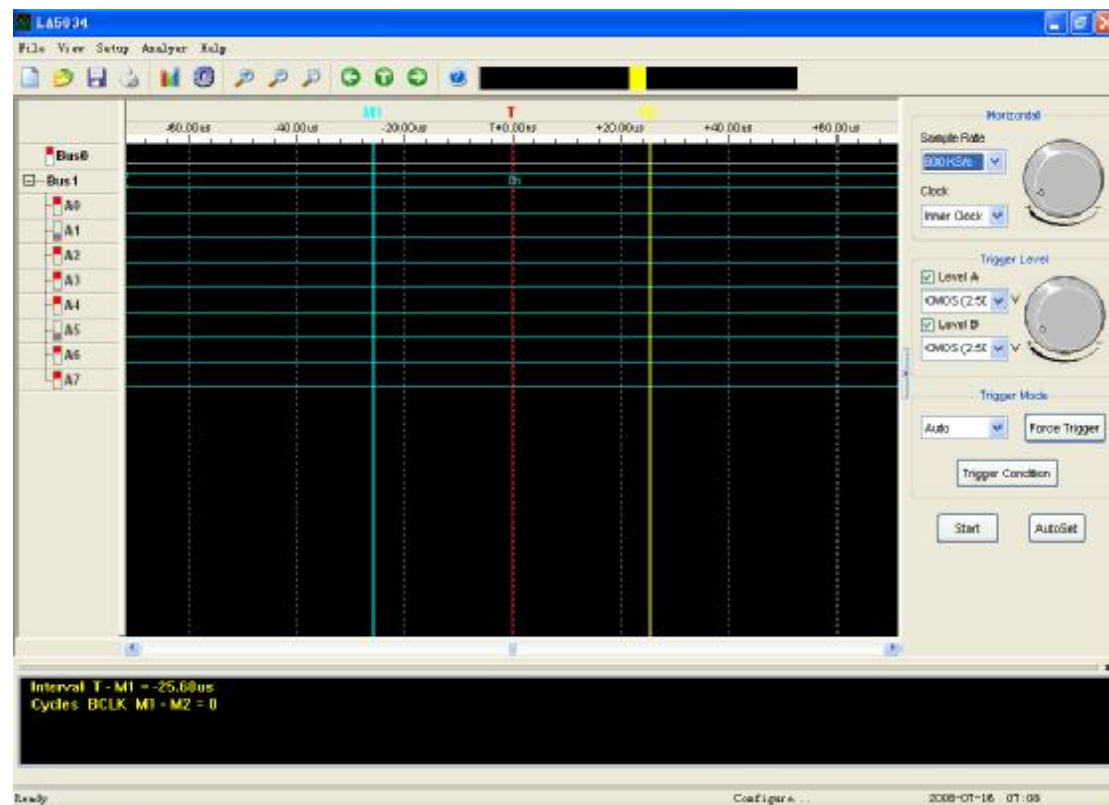

Chapter 2 Menu

This chapter focuses on the following topics:

- u File
- u View
- u Setup
- u Analyzer
- u Help

File

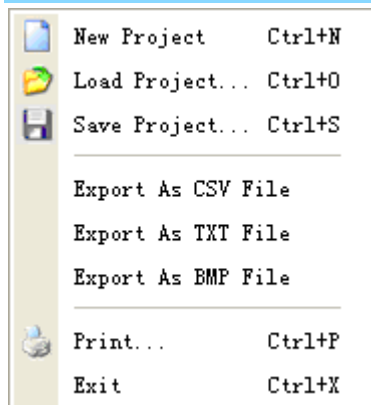

- | | | |
|---|---------------------|------------------------------|
| I | New Project: | Create a new project |
| I | Load Project: | Open an exist project |
| I | Save Project: | Save current project to File |
| I | Export As CSV File: | Export data to file as "CSV" |
| I | Export As TXT File: | Export data to file as "TXT" |
| I | Export As BMP File: | Export data to file as "BMP" |
| I | Print...: | Print the current waveform |
| I | Exit: | Exit LA5034 |

View

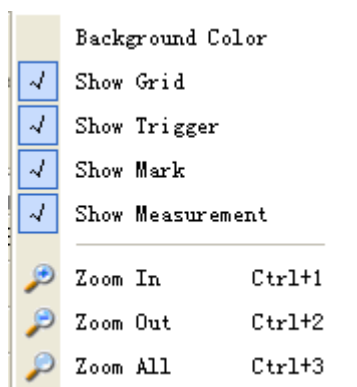

- | | | |
|---|-------------------|---|
| I | Background Color: | Modify the background color of waveform. |
| I | Show Grid: | Show or hide the grid of waveform |
| I | Show Trigger: | Show or hide the trigger line of waveform |
| I | Show Mark: | Show or hide the mark of waveform |
| I | Show Measurement: | Show or hide the measurement of waveform |
| I | Zoom In: | Zoom In the waveform |
| I | Zoom Out: | Zoom Out the waveform |
| I | Zoom All: | Zoom All the waveform |

Setup

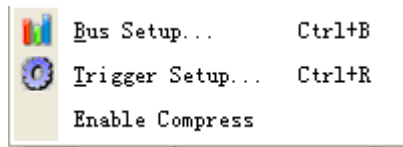

- I Bus Setup: Configure the bus and signals.
- I Trigger Setup: Configure the trigger condition.
- I Enable Compress: Set the compress enable or not.

Analyzer

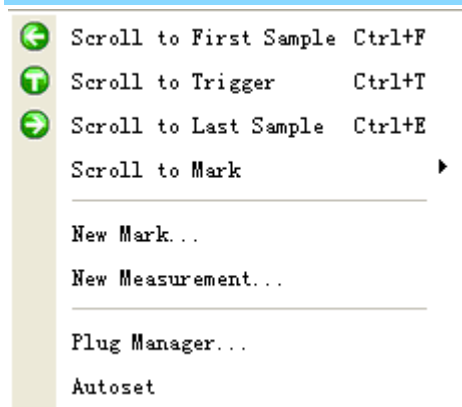

- | | | |
|--|-------------------------|---|
| | Scroll to First Sample: | Scroll to the first sample of waveform |
| | Scroll to Trigger: | Scroll to the trigger place of waveform |
| | Scroll to Last Sample: | Scroll to the last sample of waveform |
| | Scroll to Mark: | Scroll to the mark of waveform |
| | | |
| | New Mark: | Create a new Mark |
| | New Measurement: | Create a new measurement. |
| | | |
| | Plug Manager: | Configure the plug of LA5034 |
| | Auto set: | Set the waveform optimal. |

Help



- I Help Content: Open the User Manual
- I About: Show the copyright of LA5034

Chapter 3 Advanced

This chapter focuses on the following topics:

- u Clock Panel
- u Bus Panel
- u Waveform Panel
- u Measurement Panel
- u Export Data

Clock Panel

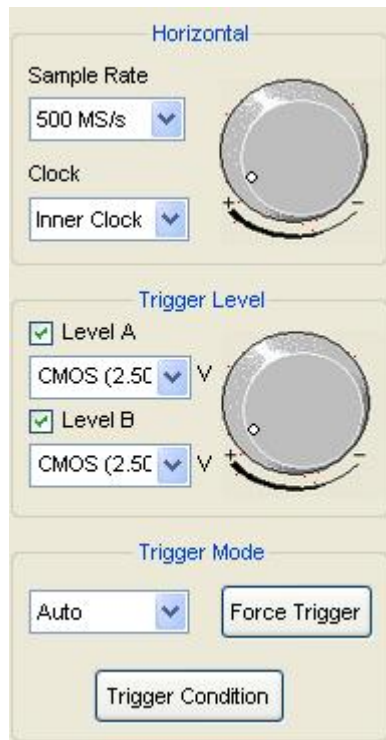

Three are three parts in this panel:

I **Horizontal:**

Set the clock and sample Rate

Inner Clock: You can select a frequency by the combo box or turn the idler wheel.

Ext Clock: You can select a signal as clock signal.

I **Trigger Level:**

Set the trigger level of signal.

Click the combo box which has 10 items. You can select one of them.

Also you can input the volt (-6.0 ~ 6.0) or use the idler wheel.

I **Trigger Mode:**

Auto: Trigger immediately ignores trigger condition continues.

Normal: Trigger by the trigger condition continues.

Single: Trigger by the trigger condition once.

Force Trigger: Trigger immediately once.

Trigger Condition: Open the trigger setup dialog.

Bus Panel

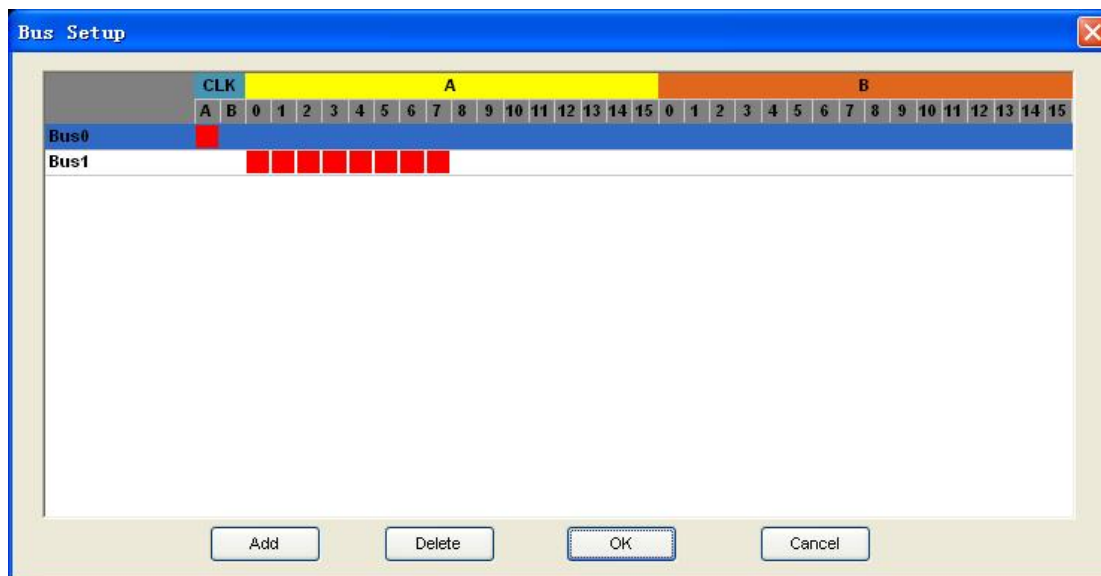

Click the menu “Setup”->”Bus Setup...” to open the dialog.

LA5034 has 34 signals, ACK, BCLK, A0 ~A15, B0~B15. You can assign the parts of them to some bus.

The list box contains all of the bus; you can add or delete the bus.

For example: Assign a bus “My Bus” which has 8 signals “ACLK, A0, A1, A2, A3, A4, A5, and A6 “.

1. Click the button “Add”. Then a new bus is added to the list.

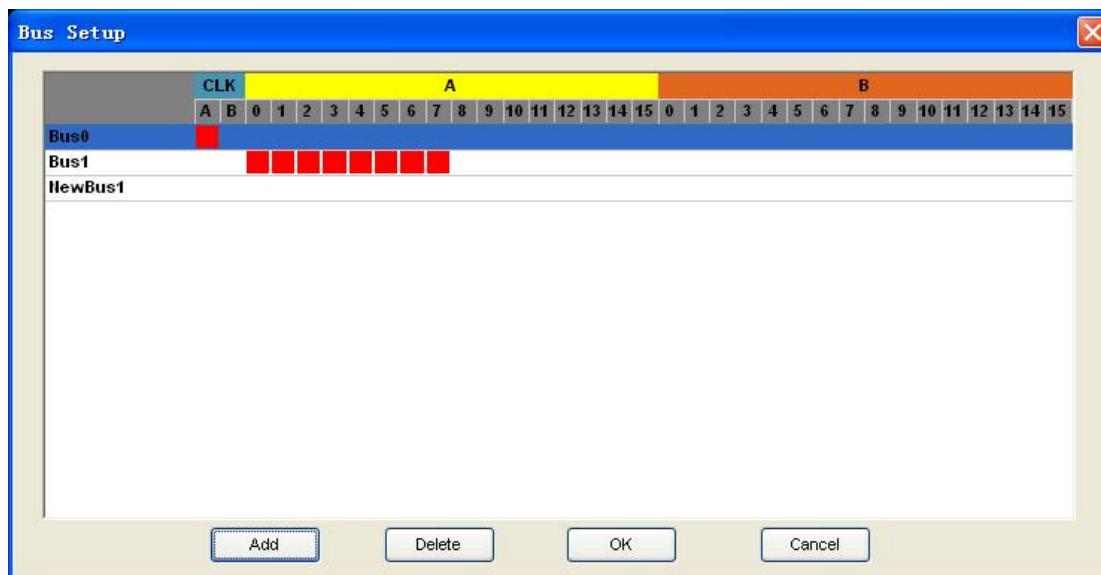

2. Click the pane under the CLKA, A0, A1, A2, A3, A4, A5, and A6. if the pane is filled of red, is means you have add the signal to the bus.

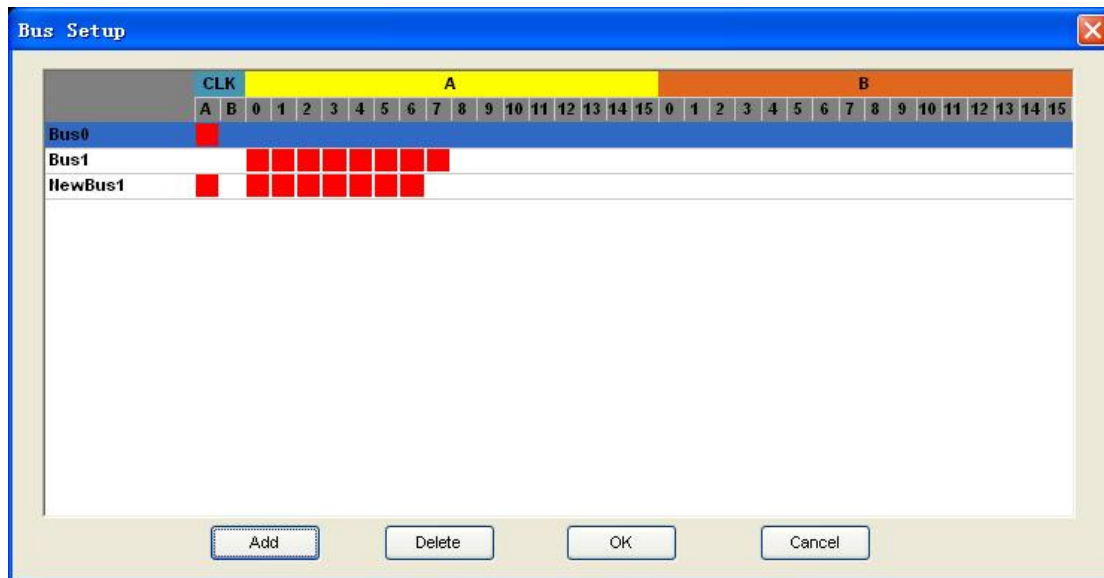

3. Double the name of the bus, which is "NewBus1" in this example. Then popup a edit box, in which you can input the "My Bus".

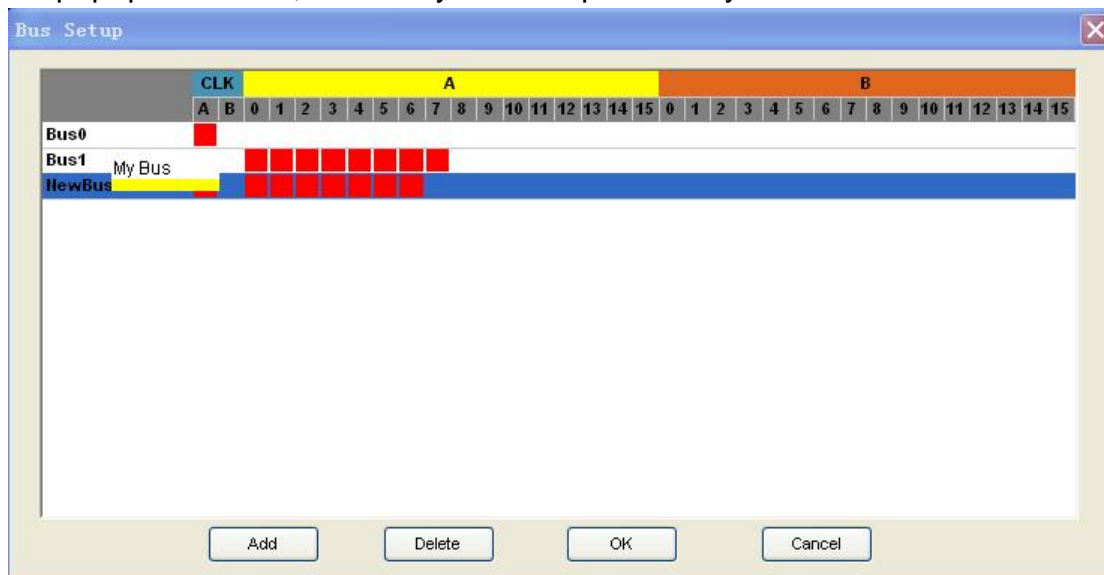

4. Then Click "OK", the "My bus" has been added to the waveform.

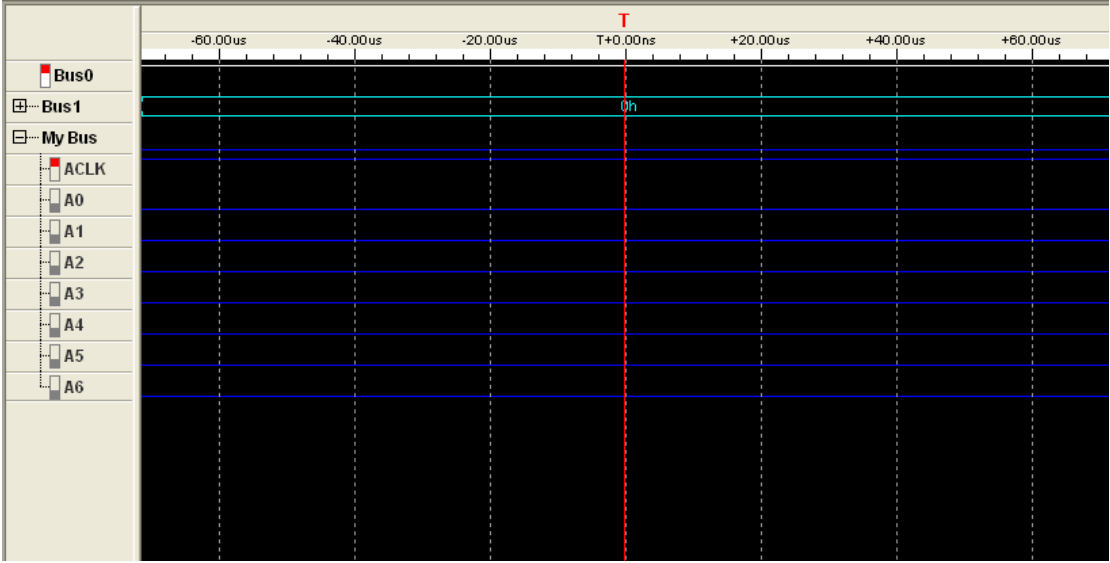

Waveform Panel

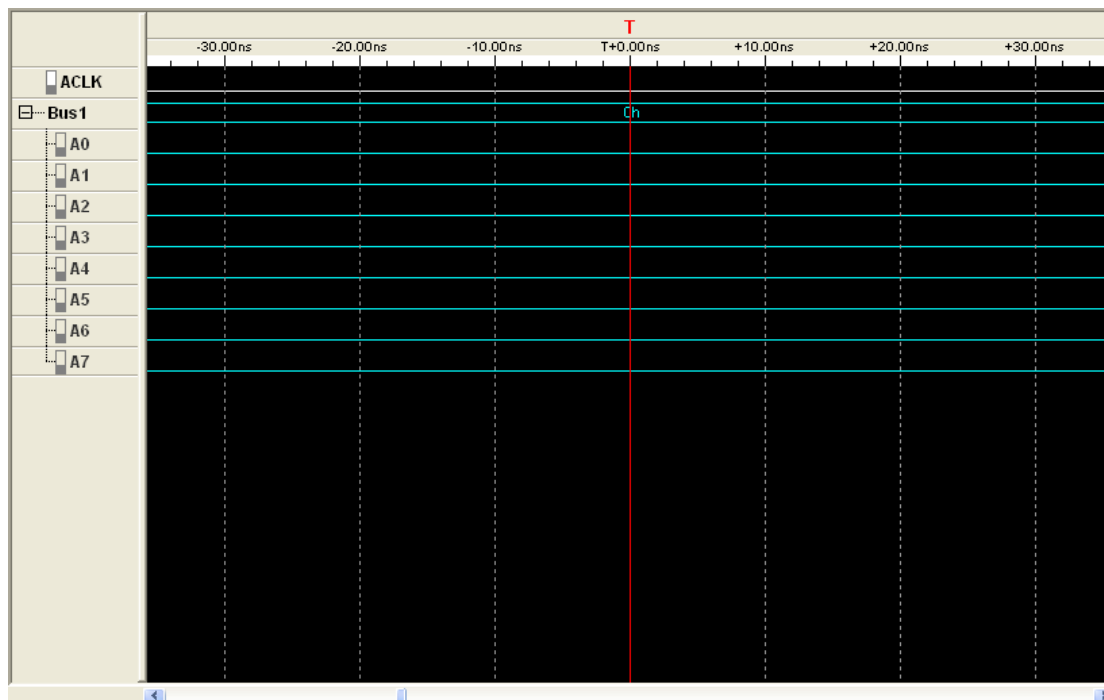

You can observe the waveform by the waveform panel in the main window. The list contains all of the bus in bus panel in the left part of the waveform panel.

Right click the name of the bus, you can configure the bus.

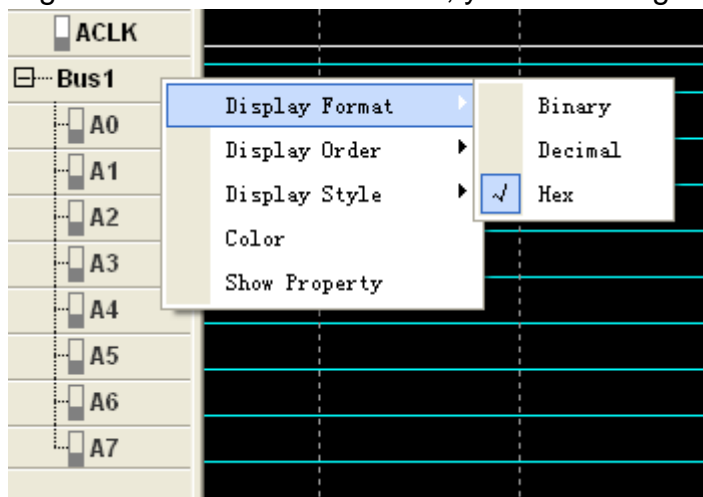

1. **Display Format:** The format of the bus data displayed on the waveform. There format such as Binary, Decimal and Hex supplied.
2. **Display Order:** The order of the signals displayed in the list.
3. **Display Style:** You can set the display style of the bus in the waveform, Analog or Digital.
4. **Color:** You can modify the color of the bus displayed in the waveform.

5. **Show Property:** Open the bus panel.

Right click the waveform, the waveform help menu popup. You can operate the LA5034 by the menu.

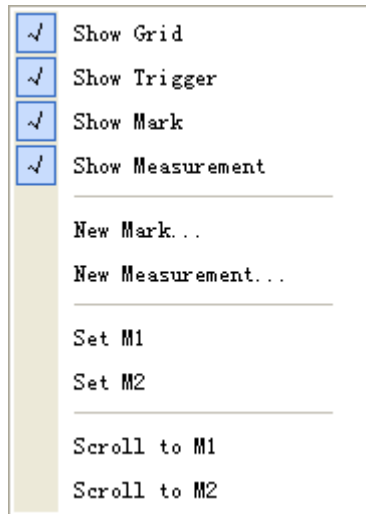

Measurement Panel

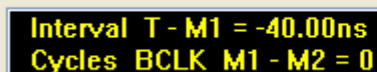

Interval T - M1 = -40.00ns
Cycles BCLK M1 - M2 = 0

Right click the measurement panel, then the menu popup.

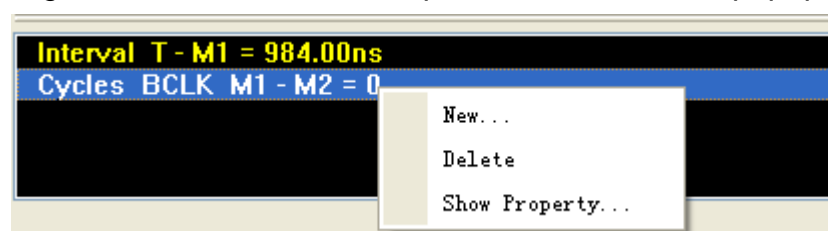

Click the “New” in the popup menu or “Analyzer”->”New Measurement” in the main menu, you will add a new measurement to the list in the measurement panel.

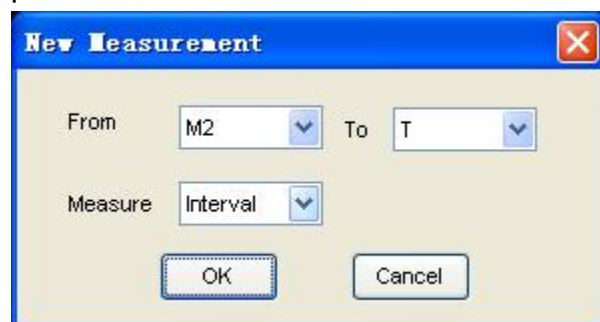

Select the “Measure” combo box. You can modify the types of measurement. There are 4 types for you, such as Interval, rate, Transitions and Cycles.

Click the “Delete”; you can delete the measurement item selected in the list. Click the “Show Property”; you can modify the measurement.

Also, you can click the main menu “Analyzer”->”New Mark” to add new mark for measurement.

Export Data

Export As CSV File

Export As TXT File

Export As BMP File

Click the menu “File”; you can export the data to file.



Data. CSV



Data. TXT



Data. bmp

If you select the CSV file, you will export the data as the following.

	A	B	C	D	E	F	G	H	I	J	K
1	Sample Pe	Trigger S	CompressData								
2	500 MS/s	2048	FALSE								
3	Sample Nu	NewGroup1	ACLK	BCLK	A0	B0	A1	B1	A2	B2	NewGroup2
4	0	ffh		1	1	1	1	1	1	1	1 11h
5	1	ffh		1	1	1	1	1	1	1	1 11h
6	2	ffh		1	1	1	1	1	1	1	1 11h
7	3	ffh		1	1	1	1	1	1	1	1 11h
8	4	ffh		1	1	1	1	1	1	1	1 11h
9	5	ffh		1	1	1	1	1	1	1	1 11h
10	6	ffh		1	1	1	1	1	1	1	1 11h
11	7	ffh		1	1	1	1	1	1	1	1 11h
12	8	ffh		1	1	1	1	1	1	1	1 11h
13	9	ffh		1	1	1	1	1	1	1	1 11h
14	10	ffh		1	1	1	1	1	1	1	1 11h
15	11	ffh		1	1	1	1	1	1	1	1 11h
16	12	ffh		1	1	1	1	1	1	1	1 11h
17	13	ffh		1	1	1	1	1	1	1	1 11h
18	14	ffh		1	1	1	1	1	1	1	1 11h
19	15	ffh		1	1	1	1	1	1	1	1 11h
20	16	ffh		1	1	1	1	1	1	1	1 11h

Chapter 4 Trigger and Plug

This chapter focuses on the following topics:

- u Base Trigger Setup
- u Advance Trigger Setup
- u Plug Manager

Base Trigger Setup

Click the menu “Setup”->”Trigger Setup”, you can configure the trigger condition.

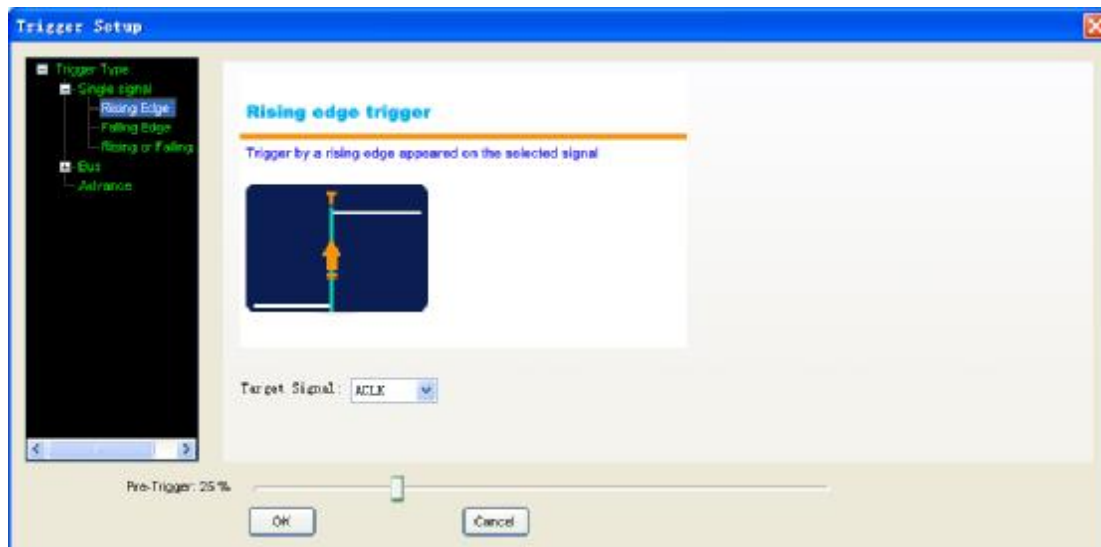

LA5034 provide 6 base trigger for you.

- I **Single signal:** Rising edge; Falling edge; Rising or falling edge.
- I **Bus:** Data, Data value delay, Data and edge

1. Rising edge:

Select the “Rising edge” in the tree; select the signal in the combo box. Then it will triggered by a rising edge appeared on the selected signal.

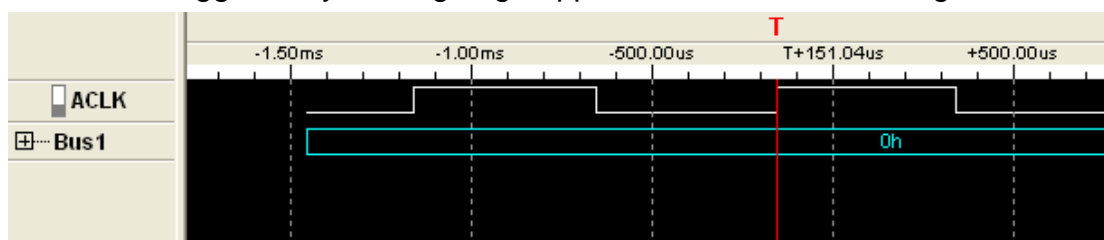

2. Falling edge:

Trigger by a falling edge appeared on the selected signal.

3. Rising or falling edge:

Trigger by a rising or falling edge appeared on the selected signal.

4. Data:

Trigger at the appearance of a specified value on the selected bus.

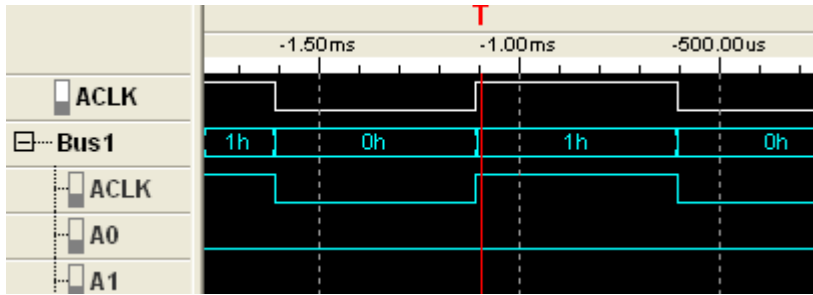

5. Data value delay:

Trigger at x time after the appearance of a specified value

6. Data and edge:

Trigger at the appearance of a specified value on the selected bus and rising, falling, or rising or falling edge of the selected signal.

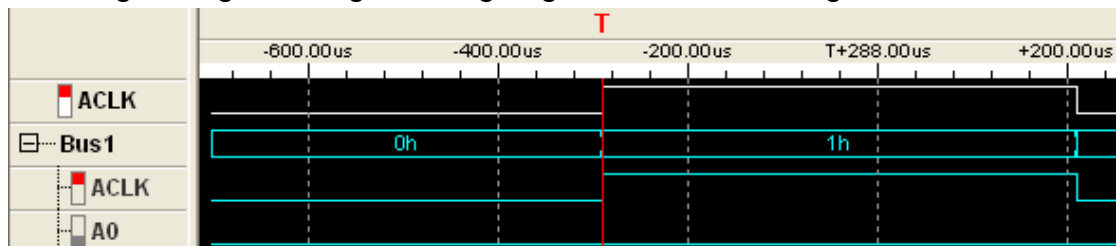

Advance Trigger Setup

If the base trigger can't satisfy you, maybe you want the advance trigger. Click the "Advance" in the tree, then you can configure the advance trigger.

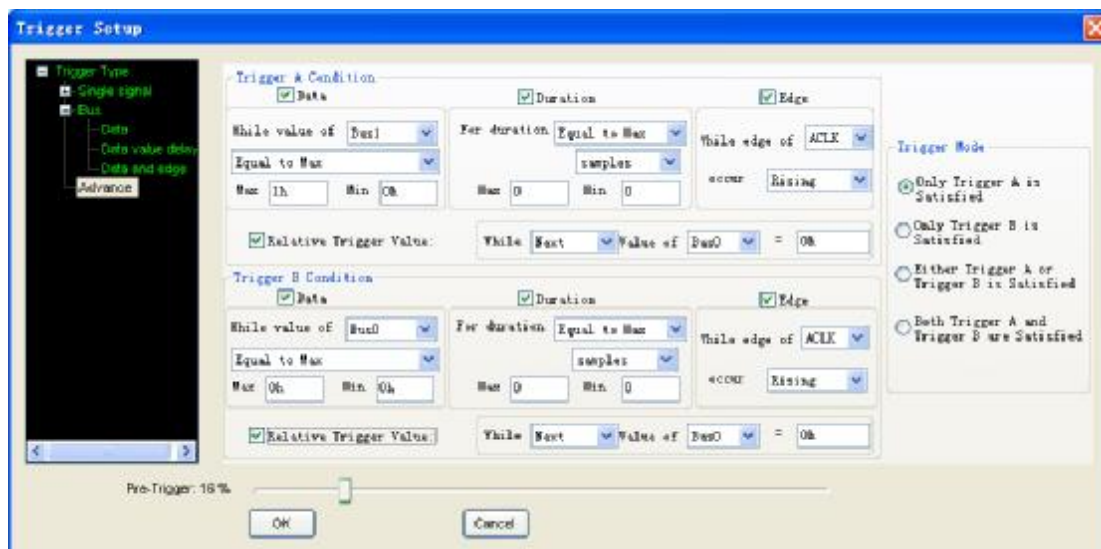

There are two trigger conditions: trigger A and trigger B. You can set the trigger mode by clicking the Trigger Mode group box.

There are four parts in each condition, Data, Duration, Edge and Relative trigger value.

Plug Manager

Click Menu “Analyzer”->”Plug Manager”.

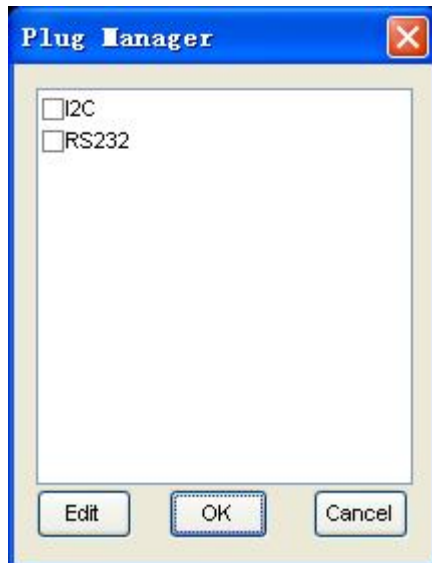

The list box contains all of the plugs installed in your computer. You can add them to waveform by checking them.

Select a plug and click the “Edit” button, you can modify the property of the plug.

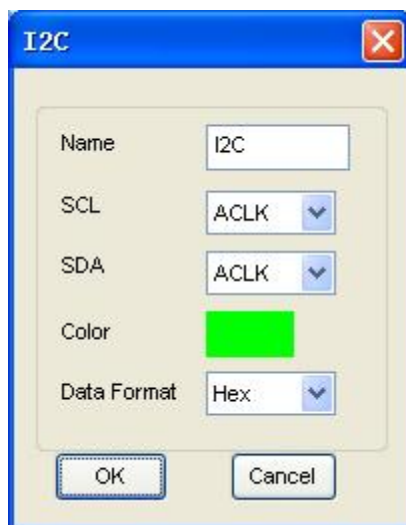

Appendix

- u Hardware specification
- u Input connector pin assignments
- u Block Diagram
- u Cleaning and Maintenance

Hardware Specification

Sampled channels	34
High input impedance	200K (C=10p)
Input voltage range	-60V~60V
Logic threshold Range	-6V~6V
Max Sample Rate	500 MHz
Max input Signal bandwidth	150 MHz
Min time resolution	2ns
Sample Depth	2KSample
Max record time (Compression mode)	10hour
Max Sample Rate (Compression mode)	200 MHz
Trigger's Max rate	250 MHz
Compatible input	TTL,LVTTL,CMOS,LVCOMS,ECL,PECL,EIA
Electrostatic Protected	15KV
Max input voltage	Max 250V 0.5s
Power	USB Port
Temperature range	-10°C~60°C

Channels

Level A

Pin Number	Wire ID	Wire Color	Contact Color
1	Ground	Black	Black
2	ACLK	Blue	Blue
3	Ground	Black	Black
4	A0	Black	Yellow
5	A1	White	Yellow
6	A2	Gray	Yellow
7	A3	Blue	Yellow
8	A4	Green	Yellow
9	A5	Yellow	Yellow
10	A6	Orange	Yellow
11	A7	Red	Yellow
12	A8	Black	Yellow
13	A9	White	Yellow
14	A10	Gray	Yellow
15	A11	Blue	Yellow
16	A12	Green	Yellow
17	A13	Yellow	Yellow
18	A14	Orange	Yellow
19	A15	Red	Yellow
20	Ground	Black	Black

Level B

Pin Number	Wire ID	Wire Color	Contact Color
1	Ground	Black	Black
2	BCLK	Blue	Blue
3	Ground	Black	Black
4	B0	Black	Orange
5	B1	White	Orange
6	B2	Gray	Orange
7	B3	Blue	Orange
8	B4	Green	Orange
9	B5	Yellow	Orange
10	B6	Orange	Orange
11	B7	Red	Orange
12	B8	Black	Orange
13	B9	White	Orange
14	B10	Gray	Orange

15	B11	Blue	Orange
16	B12	Green	Orange
17	B13	Yellow	Orange
18	B14	Orange	Orange
19	B15	Red	Orange
20	Ground	Black	Black

Block Diagram

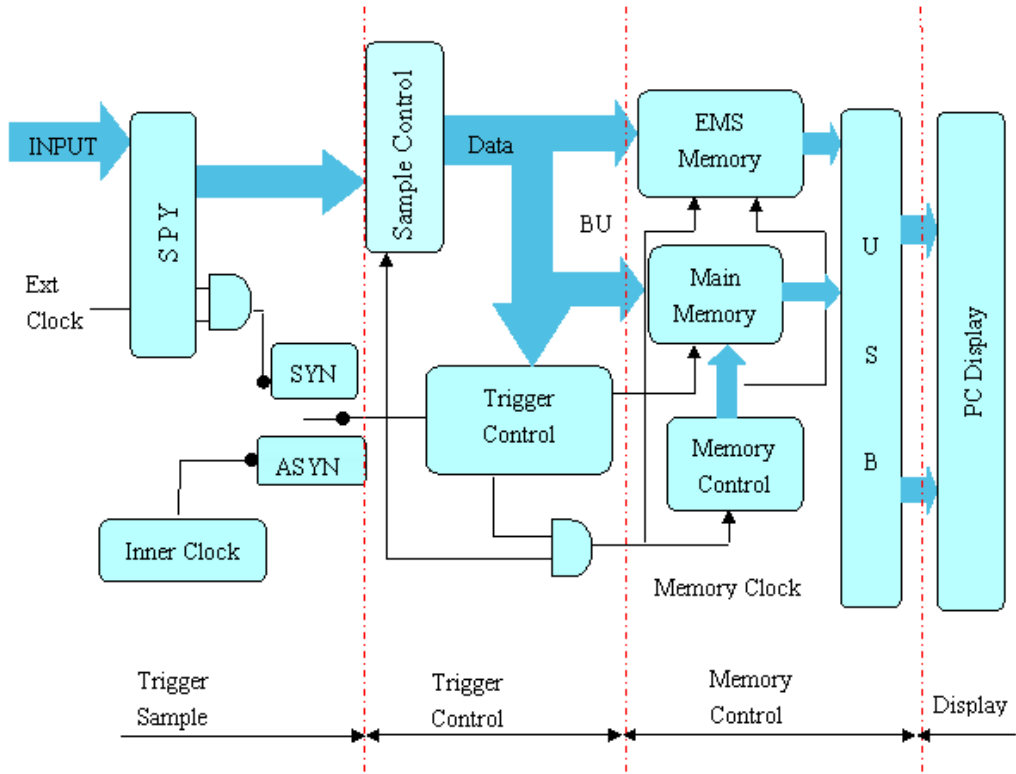

Cleaning and maintenance

Cleaning

In order to maintain the cleanliness of equipment, you need to check whether the channels are dusty or not. Please clean the out surface of the equipment follow these matters.

1. Use velvet cloth contact the surface of the equipment.
2. Pease do not use any corrosive or chemistry.

Caution: Please make sure the equipment is dry enough before going to work. Avoid mangling the equipment or hurting body because of water!

Maintenance

Don't put the equipment under the sun for a long time. Put it in wind to the best of one's abilities

Caution: In order to not mangle the equipment, you should not put it in fog, water or impregnate.